

EUROTOME - OXYTOME - PLASMATOME

Automatised thermal cutting machines



EUROTOME - OXYTOME - PLASMATOME AUTOMATISED THERMAL CUTTING MACHINES

A range of machines on tracks combining plasma and oxyfuel cutting processes.

Adapted to all needs, the mechanical structure of this range of machines can be adapted according to production, budget, dimensions and applications.

EUROTOME²

Versatile & cost effective

- 1.5m to 3.5m width and length up to 15m
- Plasma or Oxy process
- 4 tools / 200mm (oxy)



OXY/PLASMATOME²

Versatile, robust for intensive production

- 1.5m to 4.5m width and length up to 32m
- Plasma or Oxy process
- 6 tools / 300mm (oxy)



PLASMATOME² HD

Intensive production & high definition cutting

- 1.5 to 4.5m width and length up to 24m
- Plasma or Oxy process
- 2 tools / 100mm (oxy)



OXY/PLASMATOME² TWIN

Accurate, robust & versatile for high-capacity production and technological applications

- 3m to 5.5m width and length up to 32m
- Plasma or Oxy process
- 8 tools / 300mm (oxy)



Different uses, but the same level of design and equipment:



Drive units of the machine

Low-backlash, maintenance-free brushless gearmotors equipped with Ethercat technology motors and drives with absolute encoders and quick-change pinions.

Longitudinal rails

The longitudinal guide consists of sturdy rails equipped with several feet for mounting the machine even on rough floors. Permanent rail brushing system to keep the machine running optimally, even in difficult conditions. Possibility of equipping the TWIN range with the advanced rail option with linear guides.

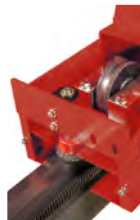

Transverse guiding

The beam is fitted with a double ball bearing rail to make the movements of the machine more fluid and thus optimize the quality cut. The TWIN range also offers a double beam to reinforce its structure to accommodate heavier tools.



Safety and compliance

All machines are equipped with safety devices (photocells, emergency stop buttons or sensitive onboard safety) ensuring optimum operator protection in accordance with Machinery Directive 2006/42/EC. Also interconnected with their environment: process and treatment of cutting fumes.

HPC III, a common centralised control system

Large tactile screen integrates machine management and cutting parameters. Quick access to manual functions to facilitate cutting operations.



HPC DIGITAL PROCESS III

Intuitive, automatic, educational

The most intuitive and efficient numerical control on the market. It fully manages the cutting machine, from the trajectory to the processes. The ergonomics of the HMI and its large 22" 16/9 touch screen make it a user-friendly and easy-to-use tool. All has been design to be intuitive but also educational with different diagrams integrated explaining simply how to use.

In particular, it includes all the important functions suited to the thermal cutting business such as: Cutting recovery menu, parametric shapes, sheet metal alignment, test menus, automatic adjustment of parameters...

How does the automatic adjustment of processes work on HPC III ?

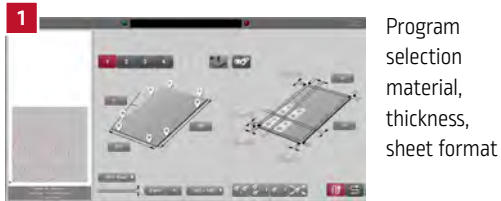

1 Program selection material, thickness, sheet format



3 The adjustment of all parameters is done automatically



2 HPC III offers one or more cutting solutions



4 ULTRA SHARP2 function integrated database offering up to 10 cutting qualities

Main features of HPC III:

- 66 Parametric forms with cutting quality management + customized shapes to customer's needs
- Scale, rotation, symmetry, choice origin program, sheet alignment...
- Plasma and flame cutting processes
- SMART DATA BASE with up to 10 qualities per parameter. Includes lead in & lead out strategy for bolt holes
- Dynamic visualization of the part and tracking of the trajectory in real time
- Skeleton cutting function, function extract part from nesting
- Program recovery menu
- Options: Tube cutting, 2nd digitized transverse axis, automatic indexing, visio-process, laser positioning or measurement, fume extraction "DIGIFILTER Inside"
- NERTAJET BEVEL HPI, digital drilling (this options can be offered with version 1 or 2 of HPC)
- 17 languages
- W10, SSD hardrive, Ethercat bus, 22"16/9 touch screen, USB, network, TeleService ETIC

OXYFUEL CUTTING PROCESS

Two systems of gas regulation with automatic cycle and a range of oxyfuel cutting torches OXYCUT MACH, MACH HP or MACH HPI.

- Cutting capacity 6 to 300mm
- Productivity
- Cutting quality
- Fitting of consumables without tools: easy & quick
- Lifetime
- Piercing up to 150mm

Fully managed by HPC III

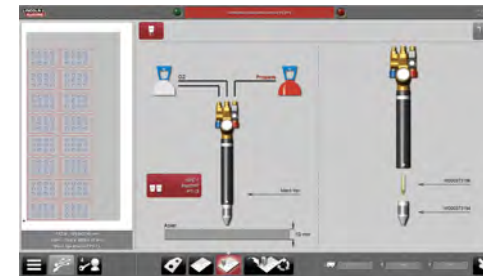

MACH HP **MACH HPI**
with internal ignition

		OXY Essential	OXY HPI2
Number of torches		4 <i>[1 module of 4]</i>	8 <i>[up to 2 modules of 4]</i>
Gas regulation		Automatic gas	
Maximum thickness: Cutting / Piercing		200 / 150mm	300 / 150mm
Tool holders	150mm stroke	Yes	
	250mm stroke	-	Yes
	Cable chain	-	Yes
	Speed	2m/min	5m/min
Oxy torches	MACH HP		✓
	MACH HPI		✓
Fixed electric igniter*		Option	-
OXY SAFE PIERCING - Including choc sensor (Probe detection) (igniter* and retractable probe)		Option	Standard
Beveling tool with tilting nozzle**			✓
Strip cutting tool**			✓
VXK cutting tool		1	2

*Integrated igniter with MACH HPI

**Use without captive probe and automatic ignition

PLASMA CUTTING PROCESSES

FineLine® HD 170/300, High Definition systems



FineLine® HD

FINELINE® HD power sources designed for high quality cutting and cost reduced production.

- Reliable technology, 3 year warranty,
- Reduction of gas consumption,
- Increased life time of wearing parts



FineLine®HD	170A@100%	300A@100%
Production piercing plate	30mm	45mm
Sheet metal edge	50mm	75mm

Advanced Process Control

The FineLine® Advanced Process Controller (APC) provides 2 new advance technologies:

- Water injection: increases speed on stainless and aluminum, reducing gas cost and improving cut edge quality, with less dross formation.
- Advanced Piercing Technology, enables 1:1 holes to be cut in heavier gauge material, achieving the same quality as large holes and helping to reduce pierce time, whilst increasing consumable life.



Plasma air 125A, low operating costs



FLEXCUT® 125 CE

Cutting and marking air Plasma installation with inverter technology. The torche LC125 allows to increase speed and quality of cut as well as the lifetime of the components.



Plasma HPI, High Power 450 & 600A

NERTAJET HPI

High precision Plasma cutting and marking system multiplying the benefits and savings thanks to its advanced features:

- CYCLE BOOST and INSTANT MARKING to reduce production time,
- MASTER HOLE and CDHC to increase cutting quality.
- Torch CPM400 or CPM PROInox, dry or vortex



FLEXCUT 125 CE	125A@100% - Cutting and marking	
Performances: Mid plate / Plate edge	Steel	30mm / 45mm
	Stainless steel	20mm / 40mm
	Aluminium	20mm / 40mm

NERTAJET HPI	450A@100%	600A@100%
Performances: Mid plate / Plate edge	Steel	50mm / 100mm
	Stainless steel	55mm / 80mm
	Aluminium	45mm / 70mm

Equipment



Equipment	FLEXCUT 125	FINELINE HD	NERTAJET HPI
Tool holder	THd 160mm	THdi 160, 350 or 500mm ; 15m/min	
Torch breakaway	✓	✓	✓
Straight Bevel X or Y	✓	✓	✓

OPTIONS - MACHINE EQUIPMENT



Tube cutting

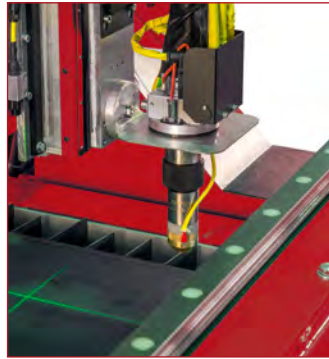

Positioning laser



Bevel HPI



Pneumatic or Wen markers

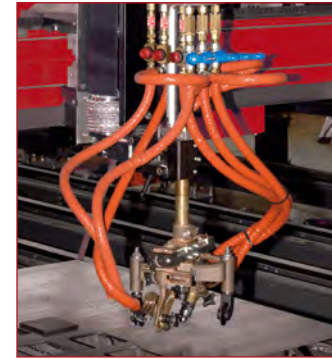

Bevelling V X K

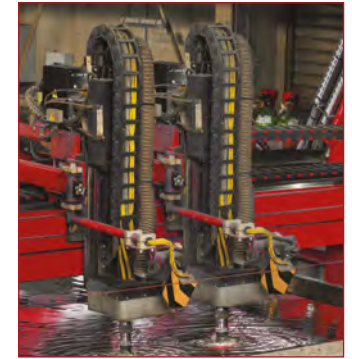

4th axis

	EUROTOME [®]	OXYTOME-PLASMATOME [®]	OXYTOME-PLASMATOME [®] TWIN	PLASMATOME [®] HD
Version	15/20/25/30/35	15/20/25/30/35/40/45	30/35/40/45/50/55	15/20/25/30/35/40/45
Cutting width (mm)	1500 to 3500	2065 to 5925	3425 to 5925	2030 to 5030
Useful length (m)	3 to 15	3 to 32	3 to 32	3 to 24
Max jog Speed XY*	21.2 m/min, optional 35.3 m/min			
Axis technology	motors and drivers brushless Ethercat with absolute encoders, planetary reducer maintenance free			
Plasma air	Flexcut [®] 125	Flexcut [®] 125	-	-
Plasma HD	Fineline [®] HD 170/300	Fineline [®] HD 170/300 NERTAJET HPI 450/600	Fineline [®] HD 170/300 NERTAJET HPI 450/600	Fineline [®] HD 170/300 NERTAJET HPI 450
Max nb. of plasma	2	2	2	2
Oxyfuel	OXY Essential	OXY Essential / OXY HPI2	OXY Essential / OXY HPI2	OXY Essential
Max nb. of oxy tool	4	8	6	1
Max thickness (mm)	200	300	300	100
Tube cutting, laser, marker	✓	✓	✓	✓
3D bevel HPI	✗	✗	✓	✗
Bevelling V X K	✓	✓	✓	✗
Operator protection	✗	✓	✓	✓
4 th axis	✗	✓	✓	✓
Automatic indexing	✗	✓	✓	✗



Operator protection

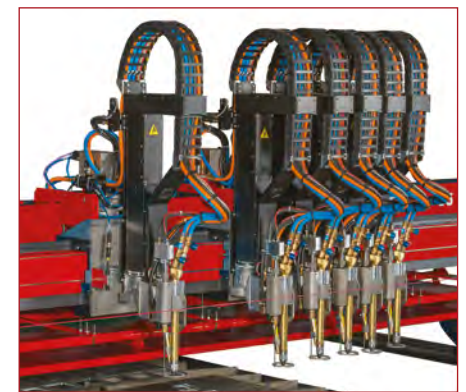

Automatic indexing

(* the values mentioned are maximum diagonal tool speeds in JOG. Production speeds are 15m/min, optional 25m/min

EUROTOME²

Quick and easy to implement,
excellent cutting quality in a flexible
and cost-effective package.

Oxy Essential manage up to 4 oxyfuel cutting torches,
with a maximum of 200mm thickness.

Plasma cutting is available either with Flexcut[®] 125,
or High Definition Fineline[®] HD 170/300.



Dimensions

Dimensions on a standard railway (length 4500mm).
Additional roller railway with 3m or 1.5m elements.

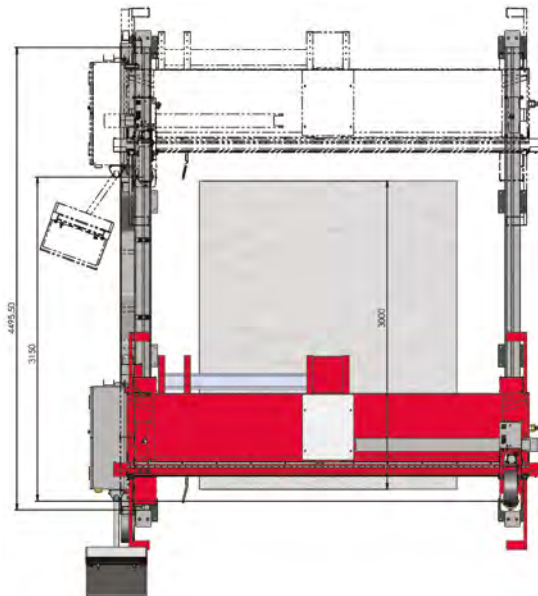
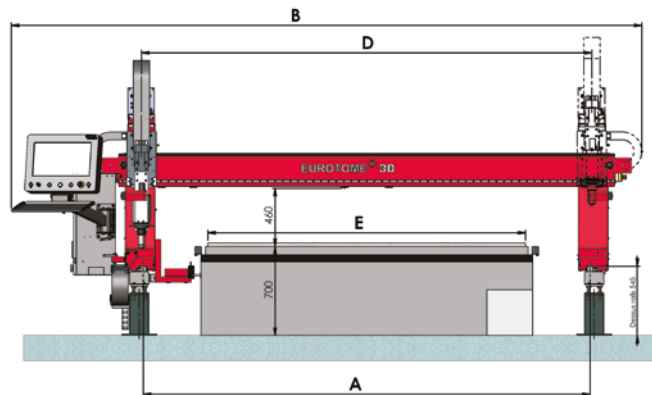

- A: Distance between rails.
- B: Overall width.
- C: Overall length.
- D: Stroke of the 1st tool-holder without an additional tool.
- E: Sheet width.

Machine	A (mm)	B (mm)	C (mm)	D* (mm)	E (mm)
T15	2015	3300	3600	2040	1500
T20	2515	3800	4100	2540	2000
T25	3015	4300	4600	3040	2500
T30	3515	4800	5100	3540	3000
T35	4015	5300	5600	4040	3500

* For the 1st additional tool-holder, remove 185mm. For the second additional T.H. remove 185mm (this also applies for the 3rd and 4th one).

OXY/PLASMATOME^②: STANDARD OR TWIN VERSION

High performance, with a full range of options to make your job in the harshest conditions.

Oxy/Plasmatome machines can carry up to 6 tools on standard version and 8 with the Twin version.

They can use plasma or flame cutting to produce intensively and on the medium or largest sheet sizes.

The Twin version, reinforced concept with double beam, allows to receive the most advanced technological options such as the 3D beveling head.



Dimensions

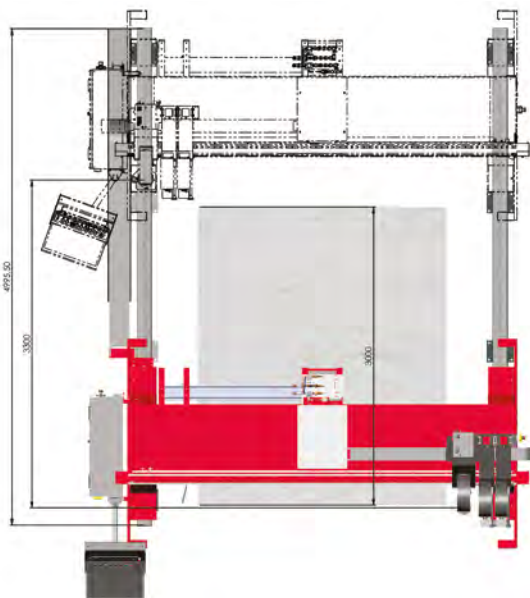
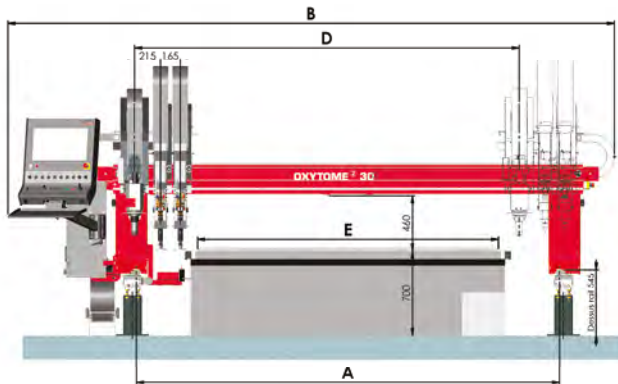

A: Distance between rails.

B: Overall width.

C: Overall dimensions with 2 corridors of 800mm.

D: Stroke of the 1st tool-holder without additional torch holder.

E: Sheet width.

Machine*	A (mm)	B (mm)	C (mm)	D** (mm)	E*** (mm)
T15	2015	3500	5100	2065	1500
T20	2515	4000	5600	2565	2000
T30	3515	5000	6600	3565	3000
T40	4515	6000	7600	4565	4000
T45	5015	6500	8100	5065	4500
T30 Twin	3905	4900	5500	2650	2500
T40 Twin	4905	5900	6500	3650	3500
T50 Twin	5905	6900	7500	4650	4500
T55 Twin	6405	7400	8000	5150	5000

* Also available in T25, T35, T35 twin, T45 twin.

** Standard version: transverse stroke with 1 tool holder. For several tool holders: remove 185mm for the 1st additional tool holder and 165mm for the following ones.

** Twin version: transverse stroke with 1 Bevel unit + 1 oxy.

*** As a general rule, tables with pneumatic activators allow to cut on the width of sheet indicated. It is important to check beforehand the compatibility of the table with machine width.

PLASMATOME² HD

High-definition plasma cutting, with separated console and lowered tracks for better accuracy.

This machine is specially dedicated for High-Definition plasma cutting process, with Finline® HD 170/300 or High-Power plasma with NERTAJET HPI 450. In option, 1 oxyfuel cutting torch can be associated.

Dimensions

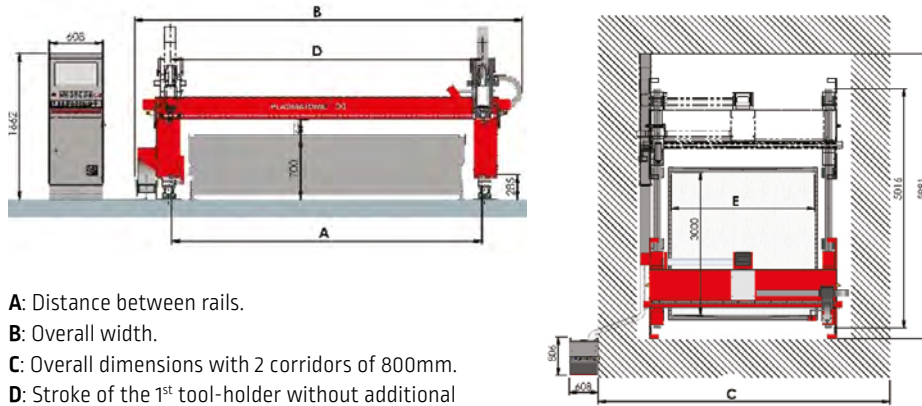

- A: Distance between rails.
- B: Overall width.
- C: Overall dimensions with 2 corridors of 800mm.
- D: Stroke of the 1st tool-holder without additional torch holder.
- E: Sheet width.



Machine	A (mm)	B (mm)	C* (mm)	D* (mm)	E** (mm)
T15	2015	2890	4600	2030	1500
T20	2515	3390	5100	2530	2000
T25	3015	3890	5600	3030	2500
T30	3515	4390	6100	3530	3000
T35	4015	4890	6600	4030	3500
T40	4515	5390	7100	4530	4000
T45	5015	5890	7600	5030	4500

* transverse stroke with 1 tool holder.
For 2 tool holders: remove 185mm.

** As a general rule, tables with pneumatic activators allow to cut on the width of sheet indicated. It is important to check beforehand the compatibility of the table with machine width.

CUSTOMER ASSISTANCE POLICY

The business of Lincoln Electric is manufacturing and selling high quality welding equipment, consumables, and cutting equipment. Our challenge is to meet the needs of our customers and to exceed their expectations. On occasion, purchasers may ask Lincoln Electric for information or advice about their use of our products. Our employees respond to inquiries to the best of their ability based on information provided to them by the customers and the knowledge they may have concerning the application. Our employees, however, are not in a position to verify the information provided or to evaluate the engineering requirements for the particular weldment. Accordingly, Lincoln Electric does not warrant or guarantee or assume any liability with respect to such information or advice. Moreover, the provision of such information or advice does not create, expand, or alter any warranty on our products. Any express or implied warranty that might arise from the information or advice, including any implied warranty of merchantability or any warranty of fitness for any customers' particular purpose is specifically disclaimed.

Lincoln Electric is a responsive manufacturer, but the selection and use of specific products sold by Lincoln Electric is solely within the control of, and remains the sole responsibility of the customer. Many variables beyond the control of Lincoln Electric affect the results obtained in applying these types of fabrication methods and service requirements.

Subject to Change – This information is accurate to the best of our knowledge at the time of printing. Please refer to www.lincolnelectriceurope.com for any updated information.



www.lincolnelectric.eu

LINCOLN[®]
ELECTRIC